

# MINIBOX NT II



PL

MINIBOX jest to oprawa przeznaczona głównie do zastosowań w sektorze handlowym. Standardowo wyposażona jest w zintegrowane źródło LED zasilane w technologii sekwencyjnej. Oprawa występuje w trzech wariantach źródeł światła: pojedynczym, podwójnym i poczwórnym. Zapewniona jest możliwość regulacji położenia źródeł światła w dwóch płaszczyznach.

EN

MINIBOX is a luminaire mainly intended for use in the commercial sector. It is usually equipped with an integrated LED source powered by sequential technology. The luminaire is available in three variants of light sources: single, double and quadruple. It provides the possibility of adjusting the light sources in two planes.

DE

MINIBOX ist eine Leuchte, die vor allem in der Handelsbranche die Anwendung findet. Standardmäßig wurde die Leuchte mit fest eingebauter, sequentieller LED Lichtquelle ausgestattet. Die Leuchte ist in drei Varianten der Lichtquelle erhältlich: einzeln, doppelt und vierfach. Die Lichtquellen können in zwei Ebenen eingestellt werden.

## OPCJE DO WYBORU / OPTIONS / OPTIONSWAHL MÖGLICH:



S mP  
sD



Tc 3000 K 4000 K  
inna/different/andere\*



biały/white/weiß  
czarny/black/schwarz  
szary/grey/grau

S - szyba hartowana / tempered glass / Scheibe aus gehärtetem Glas  
sD - klosz super dyfuzyjny / super diffusion cover / Super Diffuse Abdeckung

mP - klosz mikropryzmatyczny / micro-prism cover / mikroprismatische Abdeckung

\*Opcje dostępne na zamówienie po konsultacji z działem handlowym. / Options available on request, following consultation with the sales department. / Andere Optionen auf Bestellung nach der Beratung mit der Handelsabteilung erhältlich.

PL

### PARAMETRY TECHNICZNE

Sposób montażu: natynkowy  
Obudowa: blacha stalowa malowana proszkowo  
Napięcie zasilania: 220-240 V / 50 Hz  
Współczynnik mocy (PF): 0,99  
Klasa ochronności: I  
Wskaźnik oddawania barw CRI(Ra): 85 /90\*  
Stopień ochrony: IK07  
Stopień szczelności: IP40  
Temperatura otoczenia: od 0°C do +35°C  
Wilgotność otoczenia: 20-80%  
Trwałość (L70B50): 100 000 h

**ZASTOSOWANIE:** obiekty handlowe, biura, sale konferencyjne, hotele, restauracje

EN

### TECHNICAL PARAMETERS

Mounting: surface mounting  
Body: sheet steel powder-coated  
Power Supply: 220-240 V / 50 Hz  
Power factor (PF): 0,99  
Protection class: I  
Color rendering index CRI(Ra): 85 /90\*  
Protection marking: IK07  
Protection marking: IP40  
Ambient temperature: from 0°C to +35°C  
Ambient humidity: 20-80%  
Lifetime (L70B50): 100 000 h

**APPLICATION:** commercial buildings, offices, conference rooms, hotels, restaurants

DE

### TECHNISCHE DATEN

Montageart: zur Aufputz-Montage  
Gehäuse: pulverlackiert Stahlblech  
Speisespannung: 220-240 V / 50 Hz  
Leistungsfaktor (PF): 0,99  
Schutzklasse: I  
Farbwiedergabe Faktor CRI(Ra): 85 /90\*  
Schutzklasse: IK07  
Schutzklasse: IP40  
Umgebungstemperatur: von 0°C bis +35°C  
Umgebungsluftfeuchtigkeit: 20-80%  
Lebensdauer (L70B50): 100 000 h

**EINSATZBEREICH:** Handelsobjekte, Büros, Konferenzräume, Hotels, Restaurants

Deklarowana trwałość dotyczy opraw pracujących w temperaturze otoczenia 25°C przy zapewnionych optymalnych warunkach wentylacji. / The declared lifetime applies to fixtures operating at an ambient temperature of 25°C with ensured optimal ventilation conditions. / Die erklärte Lebensdauer bezieht sich auf Leuchten, die bei einer Raumtemperatur von 25°C und optimalen Lüftungsbedingungen arbeiten.

PRODUKTY / PRODUCTS / PRODUKTE:



[W]

[K]

[°]

[lm]

[lm/W]

Typ: ON-OFF / Type: ON-OFF / Art: ON-OFF

MINIBOX-NT-II	3000K	2x11	3000	S	81	1900	86
MINIBOX-NT-II	3000K/mP	2x11	3000	mP	79	1900	86
MINIBOX-NT-II	3000K/sD	2x11	3000	sD	78	2000	91
MINIBOX-NT-II	4000K	2x11	4000	S	81	2000	91
MINIBOX-NT-II	4000K/mP	2x11	4000	mP	79	2000	91
MINIBOX-NT-II	4000K/sD	2x11	4000	sD	78	2100	95

Całkowity strumień świetlny oprawy zmierzony za kloszem przy temp. otoczenia 25°C. Tolerancja strumienia świetlnego +/- 10%. Pomiary fotometryczne zostały wykonane zgodnie z wymaganiami normy PN-EN13032. / The total luminous flux of the luminaire measured diffuser 25°C. Luminous flux tolerance +/- 10%. Photometric measurement were examined in accordance with the PN-EN13032 system. / Gesamtlichtstrom der Leuchte, gemessen hinter der Abdeckung 25°C. Lichtstrom-Toleranz +/- 10%. Photometrische Messungen wurden nach PN-EN13032 Norm geprüft.

FOTOMETRIA / PHOTOMETRY / PHOTOMETRIE:

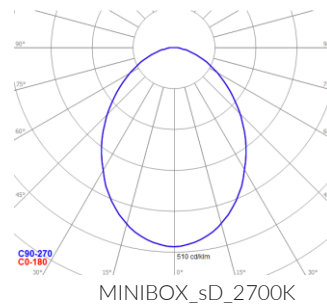
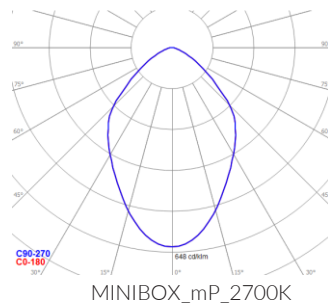
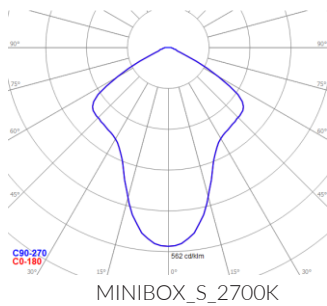

WYMIARY / DIMENSIONS / MASSE:





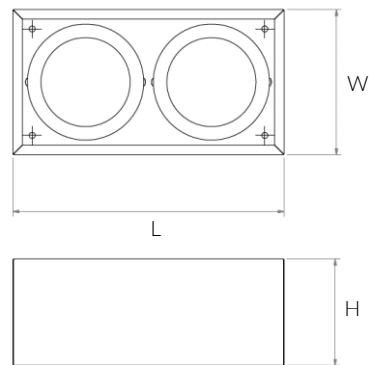















	L [mm]	W [mm]	H [mm]	[kg]
MINIBOX-NT-II	280	150	110	1,7



W związku z ciągłym rozwojem produktów zastrzegamy sobie prawo do wprowadzania zmian konstrukcyjnych w oprawach oraz aktualizowania parametrów.  
 Due to continuous product development, we reserve the right to introduce structural changes in the fixtures and to update their parameters.  
 Aufgrund der ständigen Produktentwicklung behalten wir uns das Recht vor, technische Änderungen und Aktualisierung von Parametern an Leuchten vorzunehmen.

Data aktualizacji / Revision Date / Datum der letzten Aktualisierung: 16.10.2017

LEGENDA / LEGENDA / LEGENDA:

	Deklaracja zgodności Declaration of conformity EG-Konformitätserklärung		Klasa ochronności I Protection class I Schutzklasse I		Napięcie zasilania Power supply Speisespannung
	Źródło światła LED LED source LED Quelle		Klasa efektywności energetycznej Energy efficiency class Energieeffizienzklasse		Dyrektywa RoHS The RoHS Directive RoHS Richtlinie
	Wymiary montażowe Mounting dimensions Montagemaße		Stopień szczelności IP IP protection marking Schutzklasse IP		Atest higieniczny PZH Hygiene certificate of the NIH Attest von Polnischer Hygieneanstalt
	Kod produktu Code Artikelnummer		Rodzaj klosza Cover Abdeckung		Moc oprawy Luminaire power Leistung der Leuchte
	Kąt rozsyłu światłości Light distribution angle Winkel der Lichtverteilung		Wymiary Dimensions Masse		Temperatura barwowa Color temperature Farbtemperatur
	Strumień świetlny Luminous flux Lichtstrom		Skuteczność świetlna Luminous efficiency Lichtausbeute der Leuchte		System sterowania DALI DALI control system Steuersystem DALI
	Kolor oprawy Luminaire color Leuchte Farbe		Waga Weight Gewicht		